

Shure PGX Wireless



PGX sans fil de Shure

Shure PGX Drahtlos

Sistema inalámbrico Shure PGX

Shure radiomicrofoni Serie PGX

Shure PGX Sem Fio

Беспроводные системы Shure PGX Wireless

Shure PGX ワイヤレス

Shure PGX 무선

Shure PGX 无线系统

SHURE®

PGX Wireless

Quick Start Guide

Mise en service rapide
Schnelles Einrichten

Preparación Rápida
Installazione rapida

Montagem Rápida
クイックセットアップ

快速设置指南
빠른 설정

Быстрая настройка
الأعداد السريع

1

connect receiver power cable

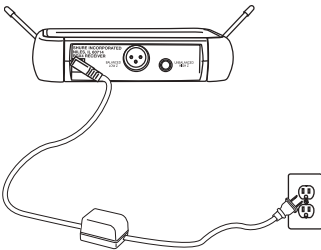

2

connect mixer or amplifier

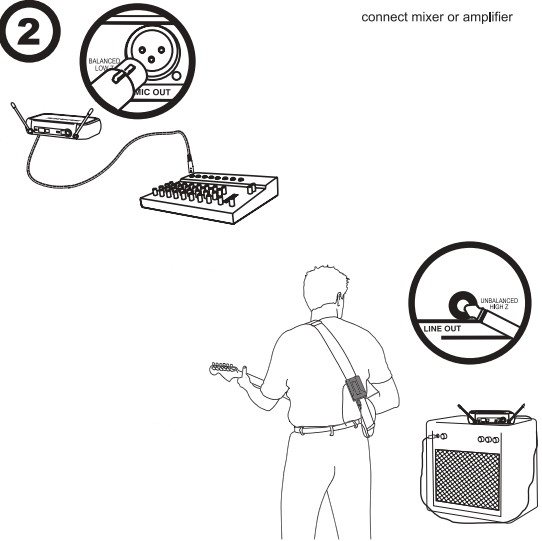

3

2 x AA

add transmitter batteries

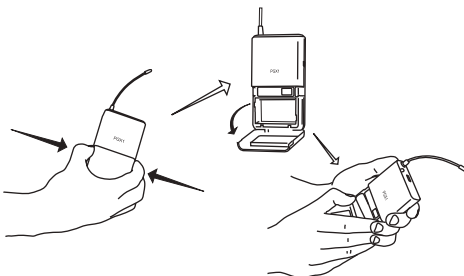

PGX1

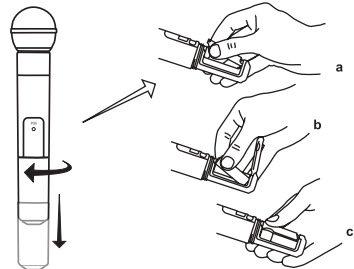

PGX2

4



power

scan for a clear channel and power up

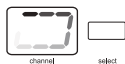
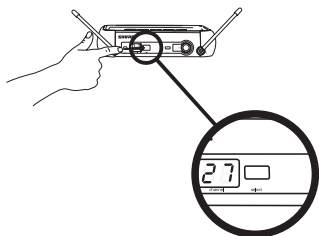

PGX1

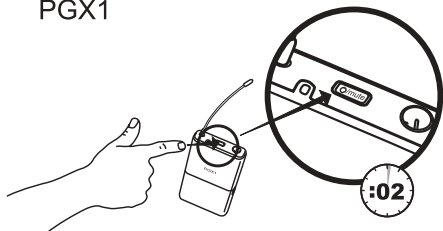

PGX2

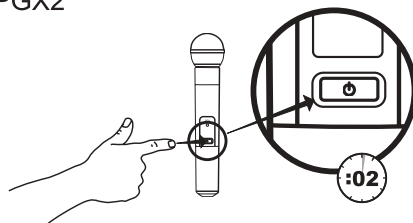

5

ready ?

automatic transmitter setup

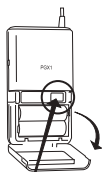

IR port

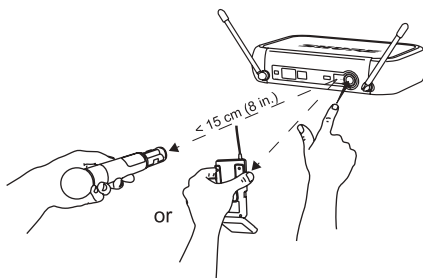

ready OK!

For detailed system information, see page 1 of the PGX user guide.

Pour plus de détails sur le système, voir la page 7 du guide d'utilisation du PGX.

Detaillierte Informationen zum System befinden sich auf Seite 13 der PGX-Bedienungsanleitung.

Para información más detallada del sistema, vea la página 19 de la guía del usuario del sistema PGX.

Per informazioni dettagliate sul sistema, consultare pagina 25 della guida all'uso del sistema PGX.

Para informações detalhadas sobre o sistema consulte a página 31 do guia do usuário do PGX.

システム情報の詳細は、PGX取扱説明書の43ページを参照してください。

关于详细的系统信息，请参考PGX用户手册第55页。

상세한 시스템 정보에 대해서는 PGX 사용자 안내서의 49 페이지를 참조하십시오.

Подробные сведения о системе см. на с. тр. 37 руководства пользователя PGX.

للحصول على الإصدار العربي لهذا المستند، يرجى زيارة موقعنا <http://www.shure.com>

Shure PGX Wireless

System Components

All systems include:

- PGX4 receiver
- 2 AA batteries
- Power supply
- User guide

Vocalist systems include:

- Microphone Head (choice of PG58, SM58®, SM86, Beta 58A® or Beta 87A)
- PGX2 handheld transmitter
- Microphone clip

Lavalier, Headworn, and Instrument systems include:

- PGX1 bodypack transmitter
- Microphone (choice of WL93, WL185, PG30 or Beta 98H/C™)

Guitar systems include:

- PGX1 bodypack transmitter
- 1/4" to mini 4-pin guitar cable

PGX4 Receiver Features

Front Panel

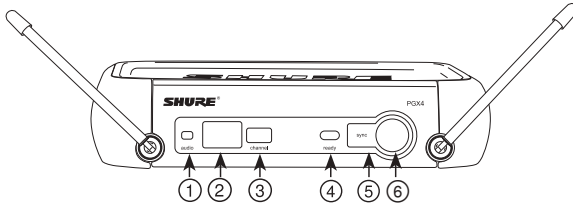

- 1 audio LED**
Indicates strength of incoming audio signal: green for normal, amber for strong and red for clipping.
- 2 LED Screen**
Displays group and channel setting. See "Single System Setup" for details.
- 3 channel button**
Changes group and channel setting. See "Single System Setup" for details.
- 4 ready LED**
Indicates system ready and receiving an RF signal from the transmitter.
- 5 Infrared (IR) port**
Sends IR signal to transmitter for sync.
- 6 sync button**
Press to synchronize transmitter with receiver group and channel settings.

Back Panel

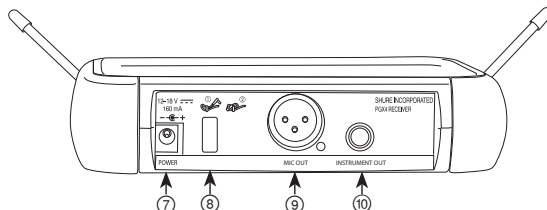

- 7 AC adapter jack**
- 8 Adapter cord tie-off**
- 9 XLR microphone output jack**
- 10 6.35 mm (1/4") instrument level output jack (unbalanced).**

Transmitter Controls and Connectors

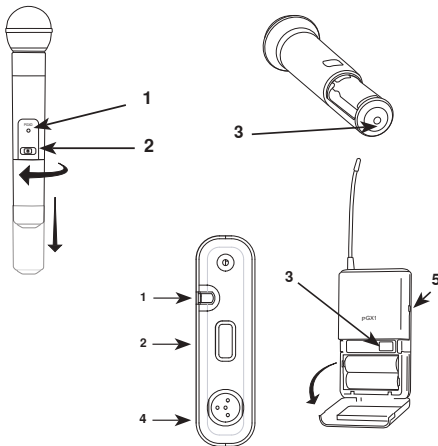

- ① Indicator LED
Displays battery level, mute, and IR transmission status (see table).
- ② Power / Mute Switch
Press to mute or unmute. Press and hold to power on or off.
- ③ Infrared (IR) port
Receives infrared beam to synchronize frequencies. **When using multiple systems, only one transmitter IR port should be exposed at a time.**
- ④ 4-Pin Microphone Input Jack
- ⑤ Audio Gain Adjustment

Transmitter Indicator LED

Green	ready
Flashing green	Controls Locked
Amber	Mute On
Flashing red	IR transmission in process
Glowing red	Battery power low
Pulsing Red on startup	Batteries dead (transmitter cannot be turned on until batteries are changed)
Pulsing Red after synchronization	Transmitter and receive incompatible; contact your Shure reseller

Changing Batteries

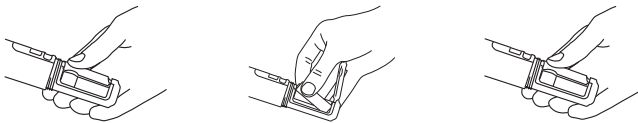

- Expected life for an Alkaline battery is approximately 8 hours.
- When the transmitter light glows red, the batteries should be changed immediately, as shown.

Wearing the Bodypack Transmitter

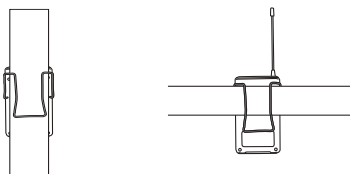

Clip the transmitter to a belt or slide a guitar strap through the transmitter clip as shown.

For best results, slide the transmitter until the belt is pressed against the base of the clip.

Adjusting Gain

PGX1

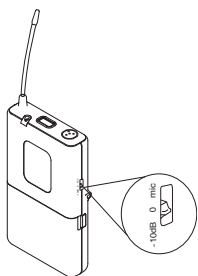

Three gain settings are available on the PGX1. Choose the appropriate setting for your instrument.

- mic: Microphone (higher amplification)
- 0: Guitar with passive pickups (medium amplification)
- -10: Guitar with active pickups (lower amplification)

If the receiver LED indicates the input volume is overloading the receiver, try switching the gain to a lower setting.

PGX2

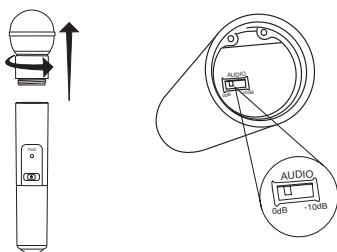

Access the gain adjustment switch by unscrewing the head of the microphone.

Two gain settings are available on the PGX2. Use the tip of a pen or a small screwdriver to move the switch.

- 0dB: For quiet to normal vocal performance.
- -10dB: Use only if audio is distorted due to high vocal levels.

Single System Setup

1 Scan

Use the scan feature on the receiver to find a clear channel.



- a** LED screen displays current channel



- b** press **channel** button to scan for a clear channel



- c** system scans for the channel with the least interference

2 Synchronize

Synchronize the transmitter to the receiver by aligning the infrared (IR) ports and pressing the **sync** button. **Make sure the IR ports are closely aligned.**

After a successful sync, the transmitter LED momentarily flashes red and the receiver **ready** light illuminates.

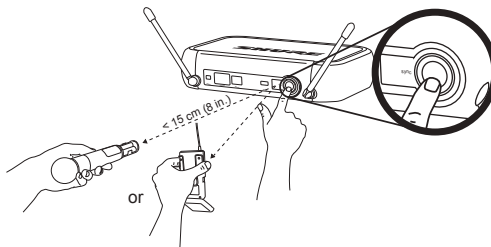

Multiple System Setup

Use the following steps to ensure the best performance when installing multiple wireless systems at the same location.

1. Turn all receivers **on** and all transmitters **off**.
Note: Turn on any other digital equipment that could cause interference during the performance so it will be detected during the frequency scans in the following steps.
2. Make sure the group number is the same for all receivers (see Manual Group Selection).
3. Perform a scan using the first receiver.
4. Turn on the first transmitter and sync it to the receiver.
5. Repeat for each system.
 - **Important:** After syncing each transmitter, leave it on so that scans from the other receivers will not select that channel.
 - Be sure only one transmitter IR port is exposed when synchronizing each system.

Manual Channel and Group Selection (receiver only)

Using the receiver to scan for a channel is the best way to find the best frequency for your system. However, for multiple system setup, you may need to manually set the group number.

1. Press and hold the **channel** button.
2. Hold the button until the channel or group display begins flashing.
3. Release and press the button again to advance the setting.

At the desired channel or group number, wait for the flashing to stop. This activates the new setting.
4. Transfer the new frequency setting to the transmitter using the automatic sync function.

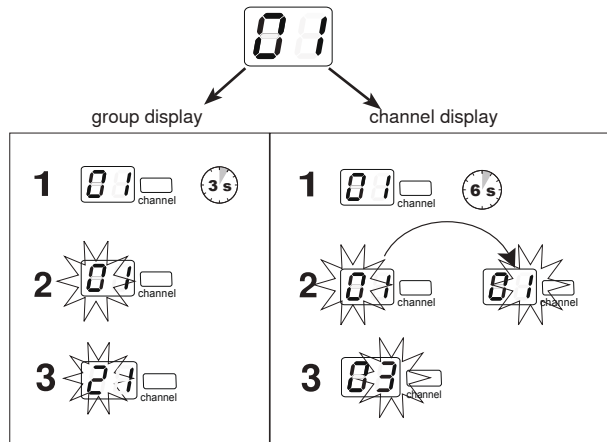

Locking and Unlocking Controls

Locking the system controls prevents accidental muting or channel adjustment during performances.

Transmitter

To lock the controls: With the transmitter **off**, hold the **power** button down until the green LED flashes (~5 seconds)

To unlock the controls: With the transmitter **on**, hold the **power** button down until the green LED flashes (~5 seconds)

Receiver

To lock the channel: Hold the **channel** button until the numbers flash (~10 seconds)

To unlock the channel: Hold the **channel** button until the numbers flash (~5 seconds)

Troubleshooting

Issue	Indicator Status	Solution
No sound or faint sound	Transmitter power light on, receiver LEDs on	<ul style="list-style-type: none"> • Perform automatic transmitter setup • Verify all sound system connections
	Receiver LED off	<ul style="list-style-type: none"> • Make sure AC adapter is securely plugged into electrical outlet • Make sure AC electrical outlet works and is supplying proper voltage
	Transmitter power light glowing or flashing red	<ul style="list-style-type: none"> • Replace transmitter batteries • If indicator continues flashing red after batteries are replaced, the transmitter and receiver may belong to incompatible frequency bands. Contact your Shure reseller for assistance.
	Transmitter power light off	<ul style="list-style-type: none"> • Turn on transmitter • Make sure the +/- indicators on batteries match the transmitter terminals • Insert fresh batteries
Distortion or unwanted noise bursts	N/A	<ul style="list-style-type: none"> • Remove nearby sources of RF interference (CD players, computers, digital effects, in-ear monitor systems, etc.) • ▶ Change receiver and transmitter to a different frequency • ▶ Reduce transmitter gain • ▶ Replace transmitter batteries • ▶ If using multiple systems, change the frequency of one of the active systems
Distortion increases gradually	Transmitter power light glowing or flashing red	Replace transmitter batteries
Sound level different from cabled guitar or microphone or when using different guitars		Adjust transmitter gain as necessary
Cannot turn transmitter on	Transmitter light flashing red	Replace transmitter batteries

SPECIFICATIONS

Working Range (Line of Sight)

100 m (300 ft)

Note: Actual range depends on RF signal absorption, reflection and interference.

RF Carrier Range

H6: 524–542 MHz, 30 mW

J6: 572.250–589.875 MHz, 30 mW

K5E: 606–630 MHz, 10 mW

L5: 644–662 MHz, 30 mW

P6: 702.200–719 MHz, 30 mW

R1: 800–820 MHz, 20 mW

T1: 846–865 MHz, 10 mW

Q8: 740–752 MHz, 10 mW

JB: 806–810 MHz, 10 mW

R14: 794–806 MHz, 20 mW

X5: 925–932 MHz, 10 mW

G4: 470.125–493.825 MHz, 30 mW

G8: 494.200–509.825 MHz, 30 mW

Note: varies by region

Audio Frequency Response

45–15000 Hz

Note: Dependent on microphone type

Total Harmonic Distortion (Ref. ± 33 kHz deviation, 1 kHz tone)

0.5%, typical

Dynamic Range

>100 dB, A-weighted

Operating Temperature Range

-18°C (0°F)– +50°C (122°F)

Note: Battery characteristics may limit this range.

Transmitter Audio Polarity

Positive pressure on microphone diaphragm (or positive voltage applied to tip of WA302 phone plug) produces positive voltage on pin 2 (with respect to pin 3 of low-impedance output) and the tip of the high impedance 1/4-inch output.

PGX1 Bodypack Transmitter

Audio Input Level

-10 dBV maximum, gain position = mic

+10 dBV maximum, gain position = 0dB

+20 dBV maximum, gain position = -10dB

Gain Adjustment Range

30 dB

Input Impedance

1 M Ω

RF Output Power

10–30 mW

varies by region

Pin Assignments

TA4M:

1: ground (cable shield)

2: + 5 V Bias

3: audio

4: Tied through active load to ground (On instrument adapter cable, pin 4 floats)

Dimensions

108 mm x 64 mm x 19 mm (H x W x D)

Weight

81 g (3 oz.), without batteries

Housing

Molded polycarbonate case

Power Requirements

2 "AA" size alkaline or rechargeable batteries

Battery Life

up to 8 hours (alkaline)

PGX2 Handheld Transmitter

Audio Input Level

+2 dBV maximum, at -10 dB gain setting

-8 dBV maximum, at 0 dB gain setting

Gain Adjustment Range

10 dB

RF Output Power

10–30 mW

varies by region

Dimensions

254 mm X 51 mm dia. (10 X 2 in.)

Weight

81 g (10.2 oz.), without batteries

Housing

Molded PC/ABS handle and battery cup

Power Requirements

2 "AA" size alkaline or rechargeable batteries

Battery Life

up to 8 hours (alkaline)

PGX4 Wireless Receiver

Dimensions

40 mm X 181 mm X 104 mm (H x W x D)

Weight

327 g (11.5 oz.)

Housing

ABS

Sensitivity

-105 dBm for 12 dB SINAD, typical

Image Rejection

>70 dB, typical

Power Requirements

12–18 V DC @ 150 mA, supplied by external power supply (tip positive)

Audio Output

Configuration

Impedance balanced

Audio Output Level (Ref. ± 33 kHz deviation with 1 kHz tone)

XLR connector: -19 dBV (into 600 Ω load)

6.35 mm (1/4") connector: -5 dBV (into 3 k Ω load)

Impedance

XLR: 200 Ω

6.35 mm (1/4"): 1 k Ω

Pin Assignments

XLR: 1=ground, 2=hot, 3=cold

6.35 mm (1/4") TRS: Tip=audio, Ring=no audio,

Sleeve=ground

NOTE:

This Radio equipment is intended for use in musical professional entertainment and similar applications. This Radio apparatus may be capable of operating on some frequencies not authorized in your region. Please contact your national authority to obtain information on authorized frequencies and RF power levels for wireless microphone products.

CERTIFICATION

PGX1, PGX2, PGX4

This Class B digital apparatus complies with Canadian ICES-003.

Cet appareil numérique de la classe B est conforme à la norme NMB-003 du Canada.

Meets requirements of EMC standards EN 300 422 Parts 1 and 2 and EN 301 489 Parts 1 and 9.

Meets essential requirements of European R&TTE Directive 99/5/EC, eligible to bear the CE mark.

PGX1, PGX2

Certified under FCC Part 74. (**FCC ID:** DD4PGX1A, DD4PGX2A, DD4SLX1, DD4SLX2). Certified by IC in Canada under RSS-123 and RSS-102. (**IC:** 616A-SLX1, 616A-SLX2).

PGX4

Approved under the Declaration of Conformity (DoC) provision of FCC Part 15. Certified in Canada by IC to RSS-123. (**IC:** 616A-PGX4A, 616A-PGX4B, 616A-PGX4C, 616A-PGX4D).

Operation of this device is subject to the following two conditions: (1) this device may not cause interference, and (2) this device must accept any interference, including interference that may cause undesired operation of the device.

The CE Declaration of Conformity can be obtained from Shure Incorporated or any of its European representatives. For contact information please visit www.shure.com

The CE Declaration of Conformity can be obtained from: www.shure.com/europe/compliance

Authorized European representative:
Shure Europe GmbH
Headquarters Europe, Middle East & Africa
Department: EMEA Approval
Wannenacker Str. 28
D-74078 Heilbronn, Germany
Phone: +49 7131 72 14 0
Fax: +49 7131 72 14 14
Email: EMEAsupport@shure.de

LICENSING INFORMATION

Licensing: A ministerial license to operate this equipment may be required in certain areas. Consult your national authority for possible requirements. Changes or modifications not expressly approved by Shure Incorporated could void your authority to operate the equipment. Licensing of Shure wireless microphone equipment is the user's responsibility, and licensability depends on the user's classification and application, and on the selected frequency. Shure strongly urges the user to contact the appropriate telecommunications authority concerning proper licensing, and before choosing and ordering frequencies.

INFORMATION TO USER

This equipment has been tested and found to comply with the limits for a Class B digital device, pursuant to Part 15 of the FCC Rules. These limits are designed to provide reasonable protection against harmful interference in a residential installation. This equipment generates, uses and can radiate radio frequency energy and, if not installed and used in accordance with the instructions, may cause harmful interference to radio communications. However, there is no guarantee that interference will not occur in a particular installation. If this equipment does cause harmful interference to radio or television reception, which can be determined by turning the equipment off and on, the user is encouraged to try to correct the interference by one or more of the following measures:

- Relocate the receiving antenna.
- Increase the separation between the equipment and receiver.
- Connect the equipment into an outlet on a circuit different from that to which the receiver is connected.
- Consult the dealer.

Note: EMC conformance testing is based on the use of supplied and recommended cable types. The use of other cable types may degrade EMC performance.

Changes or modifications not expressly approved by the manufacturer could void the user's authority to operate the equipment.

PGX WIRELESS FREQUENCY AND CHANNEL GUIDE

H6: 524.000—542.000 MHz

CH	GROUP									
	0	1	2	3	4	5	6	7	8	9
1	524.250	524.525	524.175	524.225	525.850	525.925	525.500	525.450	524.125	524.650
2	527.350	527.625	525.650	525.700	528.600	528.675	527.800	527.750	525.600	525.850
3	529.425	529.700	526.775	526.825	530.300	530.375	531.700	531.650	526.725	527.950
4	530.900	531.175	528.425	528.475	531.700	531.775	533.825	533.775	528.375	529.750
5	533.275	533.550	529.725	529.775	532.800	532.875	536.275	536.225	529.675	536.325
6	535.050	535.325	532.175	532.225	534.350	534.425	537.575	537.525	536.250	537.625
7	538.300	538.575	534.300	534.350	535.600	535.675	539.225	539.175	538.050	539.275
8	539.500	539.775	538.200	538.250	539.200	539.275	540.350	540.300	540.150	540.400
9	541.125	541.400	540.500	540.550	541.525	541.600	541.825	541.775	541.350	541.875
	Full range. Even distribution in US TV channels 23, 24, and 25		Full range. Max # of frequencies in US TV channel 23.		Full range. Max # of frequencies in US TV channel 24.		Full range. Max # of frequencies in US TV channel 25.		Full range. Max # of frequencies in US TV channels 23 and 25.	

J6: 572.250—589.875 MHz

CH	GROUP									
	0	1	2	3	4	5	6	7	8	9
1	572.250	572.525	572.175	572.225	573.850	573.925	573.500	573.450	572.125	572.650
2	575.350	575.625	573.650	573.700	576.600	576.675	575.800	575.750	573.600	573.850
3	577.425	577.700	574.775	574.825	578.300	578.375	579.700	579.650	574.725	575.950
4	578.900	579.175	576.425	576.475	579.700	579.775	581.825	581.775	576.375	577.750
5	581.275	581.550	577.725	577.775	580.800	580.875	584.275	584.225	577.675	584.325
6	583.050	583.325	580.175	580.225	582.350	582.425	585.575	585.525	584.250	585.625
7	586.300	586.575	582.300	582.350	583.600	583.675	587.225	587.175	586.050	587.275
8	587.500	587.775	586.200	586.250	587.200	587.275	588.350	588.300	588.150	588.400
9	589.125	589.400	588.500	588.550	589.525	589.600	589.825	589.775	589.350	589.875
	Full range. Even distribution in US TV channels 31, 32, and 33.		Full range. Max # of frequencies in US TV channel 31.		Full range. Max # of frequencies in US TV channel 32.		Full range. Max # of frequencies in US TV channel 33.		Full range. Max # of frequencies in US TV channels 31 and 33.	

L5: 644.000—662.000 MHz

CH	GROUP									
	0	1	2	3	4	5	6	7	8	9
1	644.250	644.525	644.175	644.225	645.850	645.925	645.500	645.450	644.125	644.650
2	647.350	647.625	645.650	645.700	648.600	648.675	647.800	647.750	645.600	645.850
3	649.425	649.700	646.775	646.825	650.300	650.375	651.700	651.650	646.725	647.950
4	650.900	651.175	648.425	648.475	651.700	651.775	653.825	653.775	648.375	649.750
5	653.275	653.550	649.725	649.775	652.800	652.875	656.275	656.225	649.675	656.325
6	655.050	655.325	652.175	652.225	654.350	654.425	657.575	657.525	656.250	657.625
7	658.300	658.575	654.300	654.350	655.600	655.675	659.225	659.175	658.050	659.275
8	659.500	659.775	658.200	658.250	659.200	659.275	660.350	660.300	660.150	660.400
9	661.125	661.400	660.500	660.550	661.525	661.600	661.825	661.775	661.350	661.875
	Full range. Even distribution in US TV channels 43, 44, and 45.		Full range. Max # of frequencies in US TV channel 43		Full range. Max # of frequencies in US TV channel 44.		Full range. Max # of frequencies in US TV channel 45.		Full range. Max # of frequencies in US TV channels 43 and 45.	

P6: 702.200—719.000 MHz

CH	GROUP									
	0	1	2	3	4	5	6	7	8	9
1	702.200	710.200	703.750	703.650	702.750	703.750	702.100	704.775	702.300	703.000
2	703.300	711.300	705.975	705.650	704.500	705.750	704.025	706.225	704.975	706.025
3	704.700	712.700	707.200	708.650	705.750	708.250	705.500	710.500	706.775	708.000
4	705.800	713.800	708.850	710.875	708.250	711.750	708.500	712.025	709.100	710.300
5	707.675	715.675	710.950	712.450	711.250	714.500	710.100	714.225	710.300	712.225
6	708.775	716.775	712.425	715.125	712.500	715.750	712.025	716.900	712.225	716.000
7			714.325	717.025	715.250	718.750	713.500	718.500	714.775	717.100
8			717.000	718.500	718.750		717.300		716.700	719.000
9			718.575							
	Optimized TV channels: TV ch. 50 702-710 MHz (same as SLX-P4, group 10)	Optimized TV channels: TV ch. 51 710-718 MHz (same as SLX-P4, group 11)	Full Range max. # of compatible frequencies (same as part of SLX-P4, group 2)	Full Range max. # of compatible frequencies (same as part of SLX-P4, group 3)	Full Range max. # of compatible frequencies (same as part of SLX-P4, group 4)	France preferred: User Group A (option 1, same as part of SLX-P4, group 5)	France preferred: User Group B (option 1, same as part of SLX-P4, group 6)	France preferred: User Group B (option 2, same as part of SLX-P4, group 7)	France preferred: User Group C (option 1, same as part of SLX-P4, group 8)	France preferred: User Group C (option 2, same as part of SLX-P4, group 9)

R1: 800.000—820.000 MHz

CH	GROUP									
	0	1	2	3	4	5	6	7	8	9
1	801.250	801.225	806.150	801.400	800.525	801.475	800.600	800.650	806.000	806.025
2	804.825	804.800	811.650	808.300	801.925	803.025	802.050	803.125	807.100	807.425
3	806.975	806.950	814.400	816.400	803.650	805.800	804.275	804.450	808.500	808.525
4	808.800	808.775	816.500		804.850	806.950	805.750	806.150	809.600	810.400
5	810.325	810.300	817.450		807.400	809.125	806.850	807.250	811.475	811.500
6	811.550	811.525	819.300		808.525	810.575	808.550	808.725	812.575	812.900
7	813.175	813.150			810.275	811.725	809.875	810.950	813.975	814.000
8	815.275	815.250			811.550	813.800	812.350	812.400		
9	816.650	816.625			813.775		813.450	813.500		
		Full Range max. # of compatible frequencies & FN / NOR / DEN (option 1, same as part of SLX-R5 group 1)	Compatible setup for use with SW200-R8 (same as SLX-R5 group 14)	Compatible setup for use with EUT-TL-TV (same as SLX-R5 group 10)	Germany preferred: User Group 4 800-814 MHz (option 1, same as SLX-R5 group 4)	Germany preferred: User Group 4 800-814 MHz (option 2, same as SLX-R5 group 5)	Sweden preferred: 800-814 MHz (option 1, same as SLX-R5 group 6)	Sweden preferred: 800-814 MHz (option 2, same as SLX-R5 group 7)	Netherlands preferred: TV ch. 63 806-814 MHz (option 1, same as SLX-R5 group 8)	Netherlands preferred: TV ch. 63 806-814 MHz (option 2, same as SLX-R5 group 9)

T1: 846.000—865.000 MHz

CH	GROUP									
	0	1	2	3	4	5	6	7	8	9
1	847.500	846.100	863.200	846.800	854.200	855.475	855.075	854.750	854.750	854.425
2	848.600	847.350	863.900	848.425	855.300	857.425	857.775	855.850	855.850	855.525
3	850.100	849.400	864.500	850.425	856.700	860.600	860.725	857.250	857.250	857.400
4	852.100	851.800		852.875	857.800			858.350	858.350	858.500
5	853.300	853.200		855.650	859.675			860.225	860.225	859.900
6	855.100			856.775	860.775			861.325	861.325	861.000
7	857.200			859.725						
8	858.650			861.550						
9	859.800			864.800						
	Compatible setup for use with EUT-VR, -VS and -VT	Compatible setup for use with EUT-TV, -TX, -TY and -TZ	European harmonized band, optimized for 863-865 MHz	Full Range max. # of compatible frequencies (same as SLX-SS, group 3)	BEL / TUR preferred: opt. TV ch: 69 854-862 MHz	UK, preferred: -CH69 Coordinated SET 1	UK, preferred: -CH69 Coordinated SET 3	UK, preferred: Co-ordinated frequencies -INDOORS (option 1)	UK, preferred: Co-ordinated frequencies -OUTDOORS (option 1)	UK, preferred: Co-ordinated frequencies -OUTDOORS (option 2)

Q8: 740.000—752.000 MHz

CH	GROUP			
	0	1	2	3
1	740.125	740.125	740.125	740.125
2	741.500	741.950	741.225	740.800
3	743.375	743.500	742.925	741.825
4	744.600	745.675	745.425	743.075
5	746.325	747.400	746.875	745.125
6	748.500	748.625	748.925	746.575
7	750.050	750.500	750.175	749.075
8	751.875	751.875	751.200	750.775
9			751.875	751.875
	Full Range	Full Range	Full Range	Full Range

R14: 794.000—806.000

CH	0	CH	FREQ.	CH	FREQ.	CH	FREQ.
1	795.150	1	794.375	1	794.100	1	794.900
2	798.100	2	797.425	2	795.300	2	796.100
3	802.200	3	803.025	3	798.550	3	799.350
4	805.350	4	804.475	4	802.150	4	802.950
				5	803.350	5	804.150
				6	804.925	6	805.725
	Full Range		Full Range		Full Range		Full Range

JB: 806.000—810.000

CH	1	2	3	4	5	6
1	806.250	806.375	806.125	806.500	806.125	806.250
2	807.500	808.625	807.375	807.375	807.375	807.250
3	809.625	809.750	809.500	808.625	808.375	808.500
4	--	--	--	809.625	809.750	809.375
	Full range	Full range	Full range	Full range	Full range	Full range

FREQUENCY BAND K5E (606–630 MHz)

CHANNEL 1 - 6		CHANNEL 11-16		CHANNEL 21-29		CHANNEL 31-39		CHANNEL 41-49	
U.K. preferred: TV ch. 38 606-614 MHz with 125 kHz guard band (same as SLX- K3E group 10)		U.K. preferred: TV ch. 38 606-614 MHz with 125 kHz guard band (same as SLX-K3E group 11)		Full Range max. # of compatible frequencies (same as SLX- K3E group 2)		Full Range max. # of compatible frequen- cies (same as SLX-K3E group 3)		Full Range max. # of compatible frequen- cies, Ch. 38 excl. (same as SLX-K3E group 4)	
1	606.350	11	606.675	21	606.125	31	606.250	41	614.550
2	607.650	12	607.775	22	607.300	32	607.375	42	615.750
3	609.750	13	609.175	23	609.250	33	608.875	43	617.550
4	610.850	14	610.875	24	610.500	34	610.950	44	618.850
5	612.425	15	612.050	25	613.100	35	612.475	45	621.025
6	613.700	16	613.575	26	615.250	36	615.300	46	622.650
				27	616.400	37	616.850	47	623.775
				28	618.000	37	619.325	48	625.675
				29	620.400	39	620.600	49	626.825

CHANNEL 51-56		CHANNEL 61-66		CHANNEL 71-76		CHANNEL 81-87		CHANNEL 91-98	
European TV chan- nel 39 optimized 614 - 622 MHz (same as SLX-K3E group 15)		European TV chan- nel 40 optimized 622 - 630 MHz (same as SLX-K3E group 16)		France preferred: User Group A 614 - 630 MHz (same as SLX- K3E group 12)		France preferred: User Group B 614 - 630 MHz (same as SLX- K3E group 13)		France preferred: User Group C 614 - 630 MHz (same as SLX-K3E group 14)	
51	614.200	61	622.200	71	615.250	81	616.775	91	615.000
52	615.800	62	623.800	72	616.500	82	618.225	92	616.225
53	616.900	63	624.900	73	619.750	83	620.500	93	618.775
54	618.475	64	626.475	74	623.500	84	621.700	94	620.700
55	620.375	65	628.375	75	626.500	85	625.500	95	621.900
56	621.500	66	629.500	76	628.250	86	626.975	96	626.025
						87	628.900	97	628.000
								98	629.100

FREQUENCY BAND X5 (925–932 MHz)

CHANNEL CH 1-5		CHANNEL 11-15		CHANNEL 21-25		CHANNEL 31-36		CHANNEL 41-46		CHANNEL 51-56	
Full range, Robust, 5 channels		Full range, Robust, 5 channels		Full range, Robust, 5 channels		Full range, Max frequencies, 6 channels		Full range, Max frequencies, 6 channels		Full range, Max frequen- cies, 6 chan- nels	
1	925.325	11	925.350	21	925.275	31	925.225	41	925.175	51	925.150
2	926.775	12	926.550	22	926.975	32	926.325	42	926.325	52	926.325
3	928.925	13	928.225	23	928.175	33	927.800	43	928.125	53	928.075
4	930.575	14	930.350	24	930.075	34	928.925	44	929.250	54	929.225
5	931.775	15	931.825	25	931.475	35	930.675	45	930.675	55	930.700
						36	931.850	46	931.775	56	931.800

FREQUENCY BAND G4 (470.125–493.825 MHz)

Channel	Group 1	Group 2	Group 3	Group 4	Group 5	Group 6
1	471.150	470.125	470.275	476.275	482.275	488.275
2	473.275	472.250	471.375	477.375	483.375	489.375
3	474.825	473.800	472.775	478.775	484.775	490.775
4	477.100	476.075	474.575	480.575	486.575	492.575
5	479.800	478.775	475.750	481.750	487.750	493.750
6	482.775	481.750	480.475	471.725	471.250	471.175
7	483.875	482.850	484.550	473.325	474.100	473.950
8	487.075	486.050	487.150	483.275	475.575	475.150
9	489.625	488.600	489.100	487.500	480.675	481.475
10	491.000	489.975	490.225	489.725	489.475	483.475
11	492.625	491.600	491.725	491.225	491.725	484.725
12	493.825	492.800	492.950	492.350	493.550	486.700

G8 FREQUENCY BAND (494.200–509.825 MHz)

Channel	Group 1	Group 2	Group 3
1	494.200	494.250	495.325
2	495.500	496.100	496.525
3	497.575	497.275	498.275
4	499.000	499.275	500.525
5	500.100	502.150	503.675
6	501.800	503.725	506.250
7	504.150	506.025	508.300
8	505.475	507.450	509.775
9	507.225	509.600	
10	508.675		
11	509.825		

FREQUENCIES FOR EUROPEAN COUNTRIES

PGX H6 524–542 MHz, max. 30 mW	
Country Code:	Frequency Range
Code de Pays:	Gamme de frequences
Codice di paese:	Gamme di frequenza
Código de país:	Gama de frecuencias
Länder-Kürzel:	Frequenzbereich
A, B, CH, CZ, D, E, EST	524–542 MHz *
F, GB, GR, H, I, IRL, L	524–542 MHz *
LT, M, NL, P, PL, SLO	524–542 MHz *
DK, FIN, N, S	*
CY, LV, SK	*
All other Countries	*

PGX J6 572–590 MHz, max. 30 mW	
Country Code:	Frequency Range
Code de Pays:	Gamme de frequences
Codice di paese:	Gamme di frequenza
Código de país:	Gama de frecuencias
Länder-Kürzel:	Frequenzbereich
A, B, CH, CZ, D, E, EST	572–590 MHz *
F, GB, GR, H, I, IRL, L	572–590 MHz *
LT, M, NL, P, PL, SLO	572–590 MHz *
DK, FIN, N, S	*
CY, LV, SK	*
All other Countries	*

PGX K5E 606-630 MHz, max. 30 mW	
Country Code:	Frequency Range
Code de Pays:	Gamme de frequences
Codice di paese:	Gamme di frequenza
Código de país:	Gama de frecuencias
Länder-Kürzel:	Frequenzbereich
A, B, CH, CZ, D, E, EST	606–875 MHz *
F, GB, GR, H, I, IRL	606–875 MHz *
L, LT, N, NL, P, PL, SLO	606–875 MHz *
DK	606–875 MHz *
S	606–875 MHz *
All other Countries	*

PGX L5 644–662 MHz, max. 30 mW	
Country Code:	Frequency Range
Code de Pays:	Gamme de frequences
Codice di paese:	Gamme di frequenza
Código de país:	Gama de frecuencias
Länder-Kürzel:	Frequenzbereich
A, B, CH, CZ, D, E, EST	644–662 MHz *
F, GB, GR, H, I, IRL, L	644–662 MHz *
LT, M, NL, P, PL, SLO	644–662 MHz *
DK, FIN, N, S	*
CY, LV, SK	*
All other Countries	*

PGX P6 702–720 MHz, max. 30 mW	
Country Code:	Frequency Range
Code de Pays:	Gamme de frequences
Codice di paese:	Gamme di frequenza
Código de país:	Gama de frecuencias
Länder-Kürzel:	Frequenzbereich
A, B, CH, CZ, D, E, EST	702–720 MHz *
F, GB, GR, H, I, IRL, L	702–720 MHz *
LT, M, NL, P, PL, SLO	702–720 MHz *
DK, FIN, N, S	*
CY, LV, SK	*
All other Countries	*

PGX R1 800–820 MHz, max. 20 mW	
Country Code:	Frequency Range
Code de Pays:	Gamme de frequences
Codice di paese:	Gamme di frequenza
Código de país:	Gama de frecuencias
Länder-Kürzel:	Frequenzbereich
A, B, CH, CZ, D, E, EST	800–820 MHz *
F, GB, GR, H, I, IRL	800–820 MHz *
L, LT, N, NL, P, PL, SLO	800–820 MHz *
DK	800.1–819.9 MHz *
S	800–814 MHz*
All other Countries	*

PGX T1 846–865 MHz, max. 10 mW	
Country Code:	Frequency Range
Code de Pays:	Gamme de frequences
Codice di paese:	Gamme di frequenza
Código de país:	Gama de frecuencias
Länder-Kürzel:	Frequenzbereich
A, B, CH, CZ, D, E, EST	846–865 MHz *
FIN, GB, H, I, IRL, L	846–865 MHz *
LT, M, NL, P, PL, SLO	846–865 MHz *
DK, F, N, S	863–865 MHz *
CY, GR, LV, SK	*
All other Countries	*

PERU DECLARATION OF CONFORMITY

Shure Incorporated
5800 W. Touhy Avenue
Niles, Illinois 60714-4608, U.S.A.
(847) 600-2000

Shure Incorporated declares that the following product

Model: PGX1-H6 (524-542MHz) PGX1-J6 (572-590MHz) PGX1-L5 (644-662MHz)

Description: UHF FM Wireless Microphone Transmitter

Has been tested and found to comply with the limits set in Peru wireless regulatory standard **RM N ° 204-2009-MTC/03**. It's effective radiated power (ERP) has been measured to be less than 10 mW, as measured in accordance with ETSI standard EN 300 422.

Signed  Date: August 24, 2009

Name, Title: Kevin Marrs, Manager, Global Compliance, Shure Incorporated

PERU DECLARATION OF CONFORMITY

Shure Incorporated
5800 W. Touhy Avenue
Niles, Illinois 60714-4608, U.S.A.
(847) 600-2000

Shure Incorporated declares that the following product

Model: PGX2-H6 (524-542MHz) PGX2-J6 (572-590MHz) PGX2-L5 (644-662MHz)

Description: UHF FM Wireless Microphone Transmitter

Has been tested and found to comply with the limits set in Peru wireless regulatory standard **RM N ° 204-2009-MTC/03**. It's effective radiated power (ERP) has been measured to be less than 10 mW, as measured in accordance with ETSI standard EN 300 422.

Signed  Date: August 24, 2009

Name, Title: Kevin Marrs, Manager, Global Compliance, Shure Incorporated



SHURE[®]

**United States, Canada, Latin
America, Caribbean:**
Shure Incorporated
5800 West Touhy Avenue
Niles, IL 60714-4608 USA
Phone: 847-600-2000
Fax: 847-600-1212 (USA)
Fax: 847-600-6446
Email: info@shure.com

www.shure.com

©2010 Shure Incorporated

Europe, Middle East, Africa:
Shure Europe GmbH
Wannenäckestr. 28,
74078 Heilbronn, Germany
Phone: 49-7131-72140
Fax: 49-7131-721414
Email: info@shure.de

Asia, Pacific:
Shure Asia Limited
22/F, 625 King's Road
North Point, Island East
Hong Kong
Phone: 852-2893-4290
Fax: 852-2893-4055
Email: info@shure.com.hk