



  
STAIRVILLE

RevueLED  
150 Profile 3200K 26°  
LED spotlight

Musikhaus Thomann  
Thomann GmbH  
Hans-Thomann-Straße 1  
96138 Burgebrach  
Germany  
Telephone: +49 (0) 9546 9223-0  
E-mail: [info@thomann.de](mailto:info@thomann.de)  
Internet: [www.thomann.de](http://www.thomann.de)

18.11.2019, ID: 412974 (V2)

# Table of contents

<b>1</b>	<b>General information</b> .....	<b>5</b>
	1.1 Further information.....	6
	1.2 Notational conventions.....	7
	1.3 Symbols and signal words.....	7
<b>2</b>	<b>Safety instructions</b> .....	<b>10</b>
<b>3</b>	<b>Features</b> .....	<b>17</b>
<b>4</b>	<b>Installation</b> .....	<b>18</b>
<b>5</b>	<b>Starting up</b> .....	<b>22</b>
<b>6</b>	<b>Connections and controls</b> .....	<b>25</b>
<b>7</b>	<b>Operating</b> .....	<b>29</b>
	7.1 Starting the device.....	29
	7.2 Main menu.....	29
	7.3 Menu overview.....	32
	7.4 Functions in DMX mode.....	33
<b>8</b>	<b>Technical specifications</b> .....	<b>34</b>

<b>9</b>	<b>Plug and connection assignments.....</b>	<b>36</b>
<b>10</b>	<b>Troubleshooting.....</b>	<b>37</b>
<b>11</b>	<b>Cleaning.....</b>	<b>39</b>
<b>12</b>	<b>Protecting the environment.....</b>	<b>40</b>

# 1 General information

This user manual contains important information on the safe operation of the device. Read and follow all safety notes and all instructions. Save this manual for future reference. Make sure that it is available to all persons using this device. If you sell the device to another user, be sure that they also receive this manual.

Our products and user manuals are subject to a process of continuous development. We therefore reserve the right to make changes without notice. Please refer to the latest version of the user manual which is ready for download under [www.thomann.de](http://www.thomann.de).

## 1.1 Further information

On our website ([www.thomann.de](http://www.thomann.de)) you will find lots of further information and details on the following points:

Download	This manual is also available as PDF file for you to download.
Keyword search	Use the search function in the electronic version to find the topics of interest for you quickly.
Online guides	Our online guides provide detailed information on technical basics and terms.
Personal consultation	For personal consultation please contact our technical hotline.
Service	If you have any problems with the device the customer service will gladly assist you.

## 1.2 Notational conventions

This manual uses the following notational conventions:

### Letterings

The letterings for connectors and controls are marked by square brackets and italics.

**Examples:** *[VOLUME]* control, *[Mono]* button.



### Displays

Texts and values displayed on the device are marked by quotation marks and italics.



**Examples:** *'24ch'*, *'OFF'*.

## 1.3 Symbols and signal words

In this section you will find an overview of the meaning of symbols and signal words that are used in this manual.

Signal word	Meaning
<b>DANGER!</b>	This combination of symbol and signal word indicates an immediate dangerous situation that will result in death or serious injury if it is not avoided.
<b>WARNING!</b>	This combination of symbol and signal word indicates a possible dangerous situation that can result in death or serious injury if it is not avoided.
<b>NOTICE!</b>	This combination of symbol and signal word indicates a possible dangerous situation that can result in material and environmental damage if it is not avoided.
Warning signs	Type of danger
	Warning – high-voltage.
	Warning – dangerous optical radiation.



Warning signs	Type of danger
	<p>Warning – suspended load.</p>
	<p>Warning – danger zone.</p>

## 2 Safety instructions

### **Intended use**

This device is intended for use as an electronic lighting effect by means of LED technology. The device is designed for professional use and is not suitable for use in households. Use the device only as described in this user manual. Any other use or use under other operating conditions is considered to be improper and may result in personal injury or property damage. No liability will be assumed for damages resulting from improper use.

This device may be used only by persons with sufficient physical, sensorial, and intellectual abilities and having corresponding knowledge and experience. Other persons may use this device only if they are supervised or instructed by a person who is responsible for their safety.

Extend the life of the device by regular breaks in operation and avoid switching it on and off frequently. This device is not suitable for continuous use.

**Safety****DANGER!****Danger for children**

Ensure that plastic bags, packaging, etc. are disposed of properly and are not within reach of babies and young children. Choking hazard!

Ensure that children do not detach any small parts (e.g. knobs or the like) from the unit. They could swallow the pieces and choke!

Never let children unattended use electrical devices.

**DANGER!****Electric shock caused by high voltages inside**

Within the device there are areas where high voltages may be present. Never remove any covers.

There are no user-serviceable parts inside.

Do not use the device if covers, protectors or optical components are missing or damaged.



### **DANGER!**

#### **Electric shock caused by short-circuit**

Always use proper ready-made insulated mains cabling (power cord) with a protective contact plug. Do not modify the mains cable or the plug. Failure to do so could result in electric shock/death or fire. If in doubt, seek advice from a registered electrician.



### **WARNING!**

#### **Eye damage caused by high light intensity**

Never look directly into the light source.



### **WARNING!**

#### **Risk of epileptic shock**

Strobe lighting can trigger seizures in photosensitive epilepsy. Sensitive persons should avoid looking at strobe lights.



**NOTICE!**

**Risk of fire**

Do not block areas of ventilation. Do not install the device near any direct heat source. Keep the device away from naked flames.



### **NOTICE!**

#### **Operating conditions**

This device has been designed for indoor use only. To prevent damage, never expose the device to any liquid or moisture. Avoid direct sunlight, heavy dirt, and strong vibrations.

Only operate the device within the ambient conditions specified in the chapter 'Technical specifications' of this user manual. Avoid heavy temperature fluctuations and do not switch the device on immediately after it was exposed to temperature fluctuations (for example after transport at low outside temperatures).

Dust and dirt inside can damage the unit. When operated in harmful ambient conditions (dust, smoke, nicotine, fog, etc.), the unit should be maintained by qualified service personnel at regular intervals to prevent overheating and other malfunction.



**NOTICE!**

**Power supply**

Before connecting the device, ensure that the input voltage (AC outlet) matches the voltage rating of the device and that the AC outlet is protected by a residual current circuit breaker. Failure to do so could result in damage to the device and possibly injure the user.

Unplug the device before electrical storms occur and when it is unused for long periods of time to reduce the risk of electric shock or fire.



**NOTICE!**

**Possible damage due to installation of a wrong fuse**

The use of different types of fuses can cause serious damage to the unit. Fire hazard!

Only fuses of the same type may be used.



### **NOTICE!**

#### **Possible staining**

The plasticiser contained in the rubber feet of this product may possibly react with the coating of your parquet, linoleum, laminate or PVC floor and after some time cause permanent dark stains.

In case of doubt, do not put the rubber feet directly on the floor, but use felt-pad floor protectors or a carpet.



### 3 Features

Special features of the device:

- 1 × warm white LED, 120 W
- Colour temperature: 3200 K
- Beam angle: 26°
- Operation in stand-alone or DMX mode (two channels)
- Operating via buttons and display on the unit
- robust space-saving housing with mounting bracket
- temperature-controlled fan cooling
- suitable for use in clubs, bars, stages, exhibitions, etc.

For technological reasons, the light output of LEDs decreases over their lifetime. This effect increases with higher operating temperature. You can extend the service life of the illuminants by providing adequate ventilation and operating the LEDs with the lowest possible brightness.

## 4 Installation

Unpack and check carefully there is no transportation damage before using the unit. Keep the equipment packaging. To fully protect the product against vibration, dust and moisture during transportation or storage use the original packaging or your own packaging material suitable for transport or storage, respectively.



### **WARNING!**

#### **Risk of injury caused by falling objects**

Make sure that the installation complies with the standards and rules that apply in your country. Always secure the device with a secondary safety attachment, such as a safety cable or a safety chain.



**NOTICE!**

**Risk of overheating**

The distance between light output and the illuminated surface must be more than 1.5 m (19.7in).

Provide sufficient ventilation.

The ambient temperature must always be below 40 °C (104 °F).



**NOTICE!**

**Use of stands**

When mounting the device onto a stand, ensure that the stand is in a safe and stable position and that the weight of the device does not exceed the maximum permissible load capacity of the stand.



### **NOTICE!**

#### **Possible data transmission errors**

For error-free operation make use of dedicated DMX cables and do not use ordinary microphone cables.

Never connect the DMX input or output to audio devices such as mixers or amplifiers.

### **Mounting options**

You can install the unit in hanging or standing position. When in use, the device must always be attached to a solid surface or an approved truss. Use the openings of the bracket provided for mounting.

Always work from a stable platform whenever installing, moving or servicing the unit. In doing so, the area underneath the unit must be cordoned off.

The safety cable must be attached to the bracket.



*Please note that this device must not be connected to a dimmer.*

## 5 Starting up

Create all connections while the device is off. Use the shortest possible high-quality cables for all connections. Take care when running the cables to prevent tripping hazards.

**Connections in DMX mode**

Connect the DMX input of the device to the DMX output of a DMX controller or another DMX device. Connect the output of the first DMX device to the input of the second one, and so on to form a daisy chain. Always ensure that the output of the last DMX device in the daisy chain is terminated with a resistor ( $110\ \Omega$ ,  $\frac{1}{4}\text{ W}$ ).

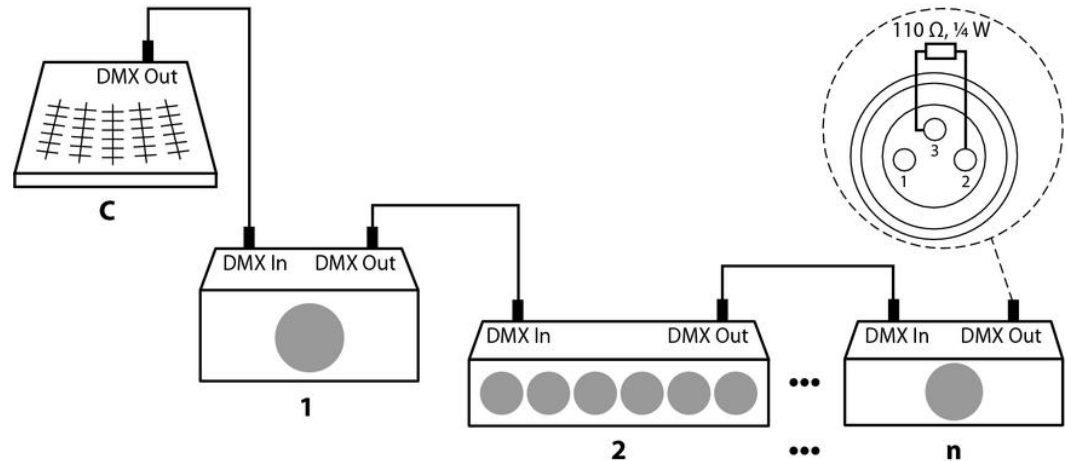

### **Connections in master/slave mode**

When you configure a group of devices in master/slave mode, the first unit will control the other units for an automatic, sound-activated, synchronized show. This function is ideal when you want to start a show immediately. Connect the DMX output of the master device to the DMX input of the first slave device. Then connect the DMX output of the first slave device to the DMX input of the second slave device and so on.



## 6 Connections and controls

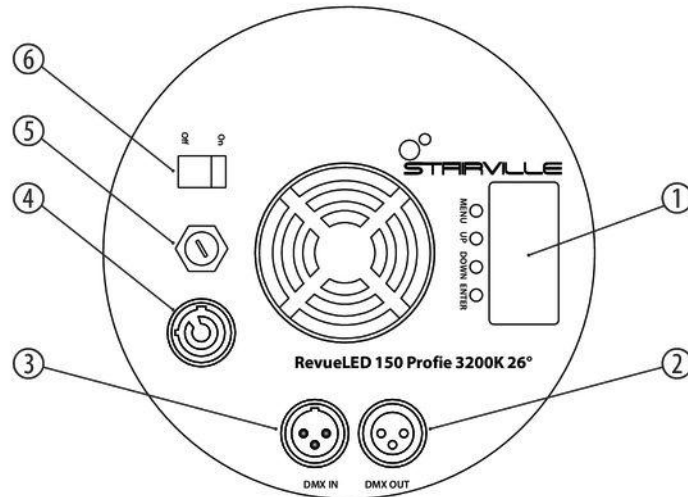

RevueLED 150 Profile 3200K 26°

1	Display with function buttons. <i>[ENTER]</i> Confirms a selected value. <i>[UP], [DOWN]</i> Increases / decreases the displayed value by one. <i>[MENU]</i> Calls up the main menu or a submenu.
2	<i>[DMX OUT]</i> DMX output
3	<i>[DMX IN]</i> DMX input
4	Power-Twist connector for the power supply of the device.
5	Fuse holder
6	Main switch. Turns the device on and off.

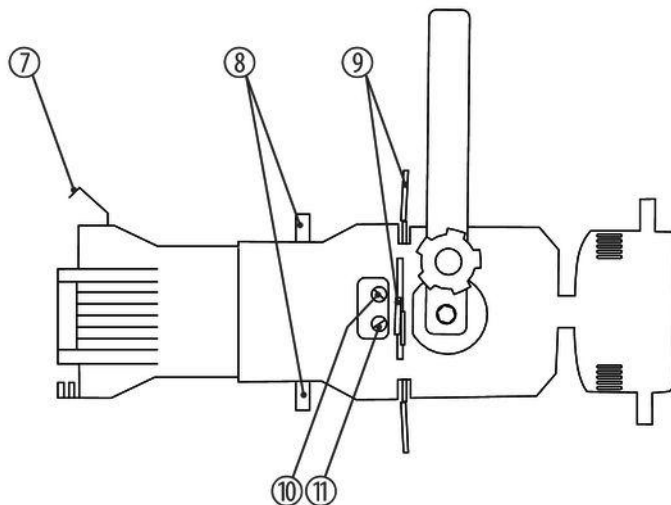

RevueLED 150 Profile 3200K 26°

7	Holder for colour films or filters.
8	Locking screw for focus.
9	Individually operable aperture slider.
10, 11	Screws for fine tuning the focus. To adjust, loosen the screws on both sides and move the lens to the desired position.

## 7 Operating

### 7.1 Starting the device

Connect the device to the power supply to start operation. The device is immediately operational and operates in the last mode with the settings last selected.

### 7.2 Main menu

#### Menu control

Press *[MENU]* to open the main menu. Use *[UP]* or *[DOWN]* to select the desired parameter or to change the respectively indicated value. When the display shows the desired parameter or value press *[ENTER]* to enter the respective submenu or confirm a new value. To return to the previous menu level without changes, press *[MENU]*.

### **DMX address**

Press *[MENU]*. Press *[UP]* or *[DOWN]* repeatedly until the display shows 'A001' and confirm with *[ENTER]*. Now you can set the number of the first DMX channel to be used by the device (DMX address). Use *[UP]* or *[DOWN]* to select a value between 1 and 511 (highest possible DMX address for 2-channel operation).

Confirm the selection with *[ENTER]*. Use *[MENU]* to return to the parent menu.

To return to the parent menu without changes, press *[MENU]* without prior confirmation.

Make sure that this number matches the configuration of your DMX controller.

### **Operating mode Slave**

Press *[MENU]*. Press *[UP]* or *[DOWN]* repeatedly until the display shows 'SL' and confirm with *[ENTER]*. Use *[UP]* or *[DOWN]* to select the desired Slave mode ('0' ... '3').

Confirm the selection with *[ENTER]*. Use *[MENU]* to return to the parent menu.

To return to the parent menu without changes press *[MENU]* without prior confirmation.

### **Strobe effect**

Press *[MENU]*. Press *[UP]* or *[DOWN]* repeatedly until the display shows 'St' and confirm with *[ENTER]*. Use *[UP]* or *[DOWN]* to specify the strobe effect frequency in a range from '0' ... '99'.

Confirm the selection with *[ENTER]*. Use *[MENU]* to return to the parent menu.

To return to the parent menu without changes press *[MENU]* without prior confirmation.

## Dimmer setting

Press *[MENU]*. Press *[UP]* or *[DOWN]* repeatedly until the display shows 'r'. Press *[ENTER]*. Use *[UP]* or *[DOWN]* to select a value between '0' (LED off) and '255' (full brightness).

This setting is only relevant if the device is not controlled via DMX. When the display shows the desired value press *[ENTER]* to confirm the selection and then *[MENU]* to return to the parent menu. To return to the parent menu without changes press *[MENU]* without prior confirmation.

## 7.3 Menu overview

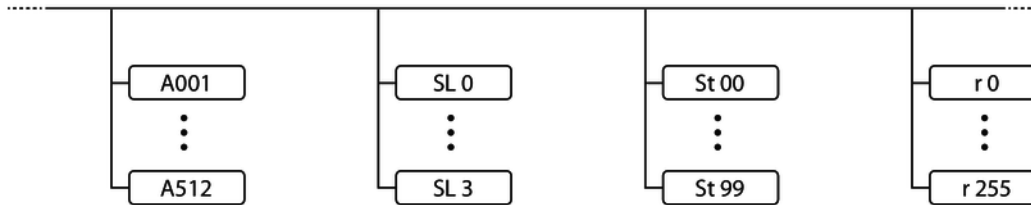



## 7.4 Functions in DMX mode

Channel	Value	Function
1	0 ... 255	Dimmer (0 % to 100 %)
2	0 ... 255	Stroboscope effect (0 % to 100 %)

## 8 Technical specifications

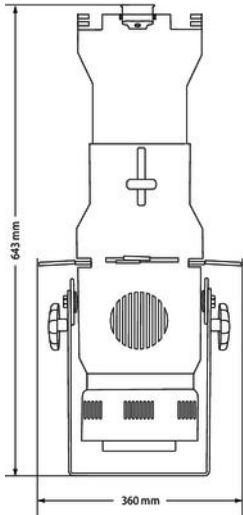

Light source	1 × LED warm white, 120 W	
Light source properties	Colour temperature	3200 K
	Colour rendering index	89 CRI Ra
Optical properties	Beam angle	26°
Control	DMX	
	Buttons and display on the unit	
Number of DMX channels	2	
Input connections	Power supply	Lockable input socket (Power Twist)
	DMX control	XLR chassis socket, 3-pin
Output connections	DMX control	XLR chassis socket, 3-pin
Power consumption	150 W	

Supply voltage	100 – 230 V ~ 50/60 Hz	
Fuse	5 mm × 20 mm, 2 A, 250 V, fast-acting	
Degree of protection	IP20	
Mounting options	Hanging, standing	
Dimensions (W × H × D)	360 mm × 465 mm × 643 mm	
Weight	7.5 kg	
Ambient conditions	Temperature range	0 °C...40 °C
	Relative humidity	50 %, non-condensing

**Further information**

Design	Complete device
Light source	LED
Fanless	No
Zoom	No

## 9 Plug and connection assignments

### Introduction

This chapter will help you select the right cables and plugs to connect your valuable equipment so that a perfect light experience is guaranteed.

Please take our tips, because especially in 'Sound & Light' caution is indicated: Even if a plug fits into a socket, the result of an incorrect connection may be a destroyed DMX controller, a short circuit or 'just' a not working light show!

### DMX connections

The unit offers a 3-pin XLR socket for DMX output and a 3-pin XLR plug for DMX input. Please refer to the drawing and table below for the pin assignment of a suitable XLR plug.



Pin	Configuration
1	Ground, shielding
2	Signal inverted (DMX-, 'cold signal')
3	Signal (DMX+, 'hot signal')

## 10 Troubleshooting



### **NOTICE!**

#### **Possible data transmission errors**

For error-free operation make use of dedicated DMX cables and do not use ordinary microphone cables.

Never connect the DMX input or output to audio devices such as mixers or amplifiers.

In the following we list a few common problems that may occur during operation. We give you some suggestions for easy troubleshooting:

Symptom	Remedy
The unit does not work, no light.	Check the mains connection and the fuse.
No response to the DMX controller.	1. Check the DMX ports and cables for proper connection.
	2. Check the address settings and the DMX polarity.
	3. Try using another DMX controller.
	4. Check to see if the DMX cables run near or alongside to high voltage cables that may cause damage or interference to DMX interface circuits.

If the procedures recommended above do not succeed, please contact our Service Center. You can find the contact information at [www.thomann.de](http://www.thomann.de).

## 11 Cleaning

### Optical lenses

Clean the optical lenses, that are accessible from the outside, regularly in order to optimize the light output. The frequency of cleaning depends on the operating environment: wet, smoky or particularly dirty surroundings can cause more accumulation of dirt on the optics of the device.

- Clean with a soft cloth using our lamp and lens cleaner (item no. 280122).
- Always dry the parts carefully.

### Fan grids

The fan grids of the device must be cleaned of any contamination, such as dust, etc. on a regular basis. Before cleaning, switch off the device and disconnect mains-operated devices from the mains. Only use pH-neutral, solvent-free and non-abrasive cleaning agents. Clean the unit with a slightly damp lint-free cloth.

## 12 Protecting the environment

### Disposal of the packaging material



For the transport and protective packaging, environmentally friendly materials have been chosen that can be supplied to normal recycling.

Ensure that plastic bags, packaging, etc. are properly disposed of.

Do not just dispose of these materials with your normal household waste, but make sure that they are collected for recycling. Please follow the notes and markings on the packaging.

### Disposal of your old device



This product is subject to the European Waste Electrical and Electronic Equipment Directive (WEEE) in its currently valid version. Do not dispose with your normal household waste.

Dispose of this device through an approved waste disposal firm or through your local waste facility. When discarding the device, comply with the rules and regulations that apply in your country. If in doubt, consult your local waste disposal facility.



RevueLED 150 Profile 3200K 26°





Musikhaus Thomann · Hans-Thomann-Straße 1 · 96138 Burgebrach · Germany · [www.thomann.de](http://www.thomann.de)